



**3004** est un profilé qui peut être installée en encastré, individuellement ou en ligne.

Structure aluminium blanc, noir ou anodisé

Diffuseur Opale, transparent ou Noir



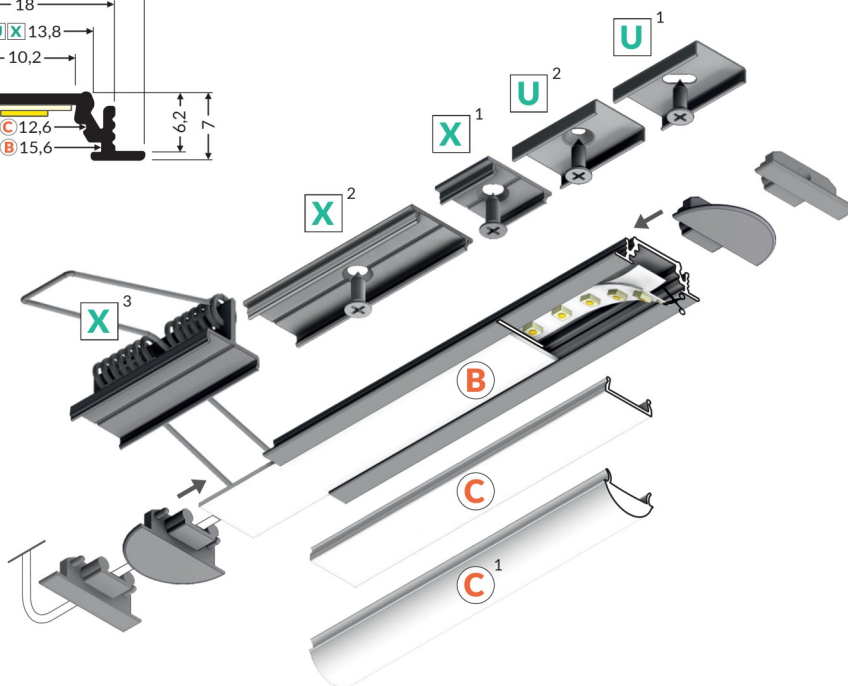
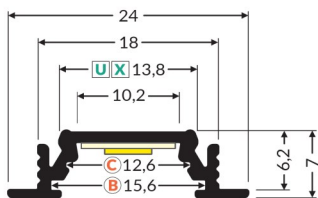

<b>U</b> <sup>1</sup>	201809	unitaire
<b>U</b> <sup>2</sup>	201854	unitaire
<b>X</b> <sup>1</sup>	201274	unitaire
<b>X</b> <sup>2</sup>	202004	unitaire
<b>X</b> <sup>3</sup>	201847	unitaire
<b>B</b>	233084	unitaire
<b>C</b>	203063	unitaire
<b>C</b> <sup>1</sup>	289166	unitaire

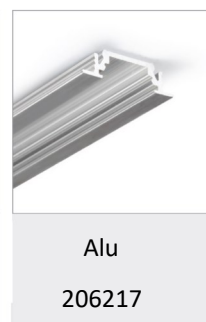
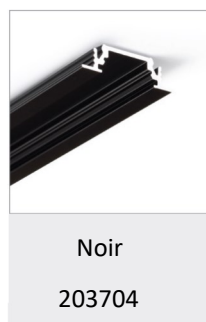
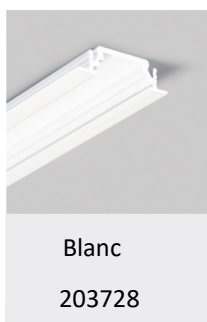

2000 mm

Embout rond « unitaire »



Blanc	257943
Anodisé (gris)	258001
Noir	257967
Alu ( silver)	257981

Embout rectangle « unitaire »

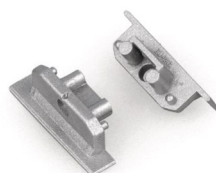

Blanc	244141
Anodisé (gris)	244189
Noir	244165
Alu ( silver)	244202

Accessoire d'angle « unitaire »

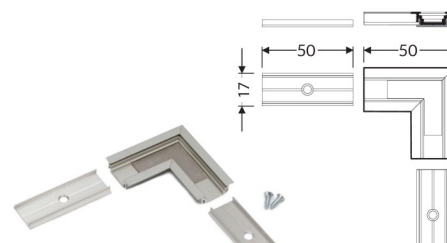

Blanc	204145
Anodisé (gris)	202509
Noir	204152